

IDP-1000-04A Touch Display Module Datasheet



1 Introduction

The IDP-1000-04A is a smart display module featuring a 10.1" TFT LCD panel with a resolution of 1280x800 and a projected capacitive multi-touch (PCAP) interface. It integrates Bridgetek's proprietary Embedded Video Engine (EVE) Graphic Controller, the BT817, to deliver rich, intuitive, and multi-touch graphic user interfaces. The module is powered by the cost-effective and high-performance Raspberry PI RP2040 microcontroller.

With built in ambient light and time-of-flight sensors, along with an RS485 interface, the IDP-1000-04A provides an intuitive and efficient solution for monitoring and triggering control events.

Unlike mobile devices that require regular recharging, this module is designed for installation in accessible locations, powered continuously via an RJ45-JST8 cable connection.

By utilizing the Raspberry Pi MCU RP2040, designers can access an extensive range of software codes and libraries online. Comprehensive resources for C/C++ and MicroPython development are readily available, facilitating efficient programming.

1.1 Features

- Driven by Raspberry Pi RP2040 Dual ARM Cortex-M0+ @ 133MHz
- Integrated with advanced BT817 Graphics Controller for enhanced performance
- Features a 10.1-inch LCD display with 1280x800 resolution and Projected Capacitive Multi-Touch (PCAP) support
- Supports 5-point multi-touch for intuitive control with fingers
- RS485 interface for programming and data communication
- Includes built-in Ambient Light and Time-of-Flight sensors
- Equipped with a built-in buzzer for audio feedback
- Comes with two RGB LED Light Strip Indicators
- Powered by a 24VDC source via an RJ45-JST8 cable.
- Sleek and modern design

Support Graphics design with EVE Toolchains and software sample codes

Neither the whole nor any part of the information contained in, or the product described in this manual, may be adapted or reproduced in any material or electronic form without the prior written consent of the copyright holder. This product and its documentation are supplied on an as-is basis and no warranty as to their suitability for any particular purpose is either made or implied. Bridgetek Pte Ltd will not accept any claim for damages howsoever arising as a result of use or failure of this product. Your statutory rights are not affected. This product or any variant of it is not intended for use in any medical appliance, device or system in which the failure of the product might reasonably be expected to result in personal injury. This document provides preliminary information that may be subject to change without notice. No freedom to use patents or other intellectual property rights is implied by the publication of this document. Bridgetek Pte Ltd, 1 Tai Seng Avenue, Tower A, #03-05, Singapore 536464. Singapore Registered Company Number: 201542387H

2 Part Number/Ordering Information

Part No.	Description
IDP-1000-04A	Intelligent Display Product 10.1 inch with Enclosure

Table 1 - Part Number/Ordering Information

Table of Contents

1	Introduction.....	1
1.1	Features.....	1
2	Part Number/Ordering Information.....	2
3	Hardware Features	5
3.1	PCBA Profile	6
3.1.1	Mainboard	6
3.1.2	Sensor Board	6
3.1.3	Sound Board.....	7
3.1.4	System Indicator Board	7
3.1.5	Key Features	8
3.2	PCB Profile	8
3.3	Connectors, Switches and Buttons	11
3.3.1	Mainboard	11
3.3.2	System Indicator Board	14
3.3.3	Sensor Board	15
3.3.4	Sound Board.....	15
3.3.5	Switches and Buttons	16
4	Board Schematics	17
5	Device Description and Configuration	22
5.1	Power Supply	23
5.2	Microcontroller	23
5.3	Graphic Controller	23
5.4	8-position JST Connector	23
5.5	4-position JST Connector	24
5.6	Reset Button	24
5.7	ID Switch	24
5.8	Buzzer	24
5.9	Time-of-Flight Sensor.....	24

5.10	Ambient light Sensor	24
5.11	LED Indicator	24
5.12	JST8-RJ45 Cable	25
6	Specifications.....	26
6.1	Electrical Specifications.....	26
6.2	Optical Specifications	27
7	Mechanical Dimensions.....	28
8	Package Contents, Mounting and Disassembly Guide.....	30
8.1	Package content.....	30
8.2	Mounting Guide	30
8.3	Disassembly Guide	33
9	Software Setup Information	35
9.1	Startup Test	35
9.2	Downloading Firmware	36
9.3	Software Development Tools and Support.....	36
10	Disclaimer Notice: Use of Third-Party Software or Websites	37
11	Warranty Statement.....	38
12	Contact Information.....	39
	Appendix A – References.....	40
	Document References	40
	Acronyms and Abbreviations	40
	Appendix B – List of Tables & Figures.....	42
	List of Tables	42
	List of Figures	42
	Appendix C – Revision History.....	44

3 Hardware Features

The IDP-1000-04A module features a 10.1-inch TFT LCD and CTP panel, with dimensions of 251mm (L) X 168mm (W) X 21.5mm (T).

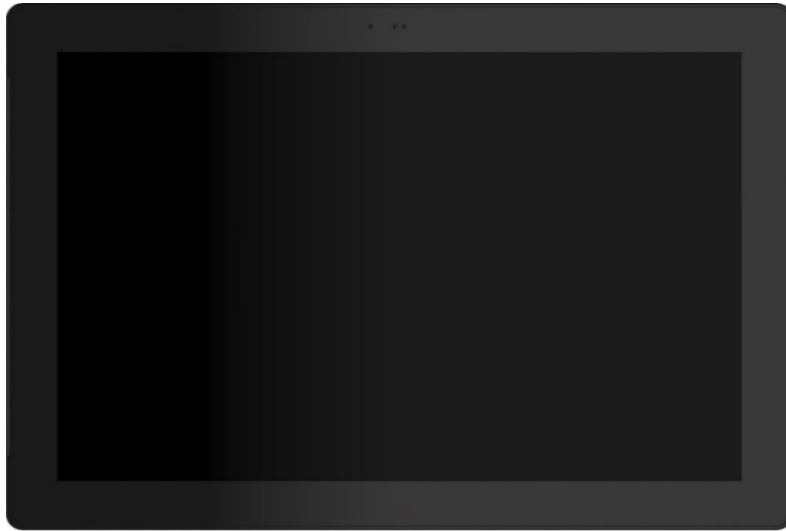

Figure 1 - Front View of IDP-1000-04A Module

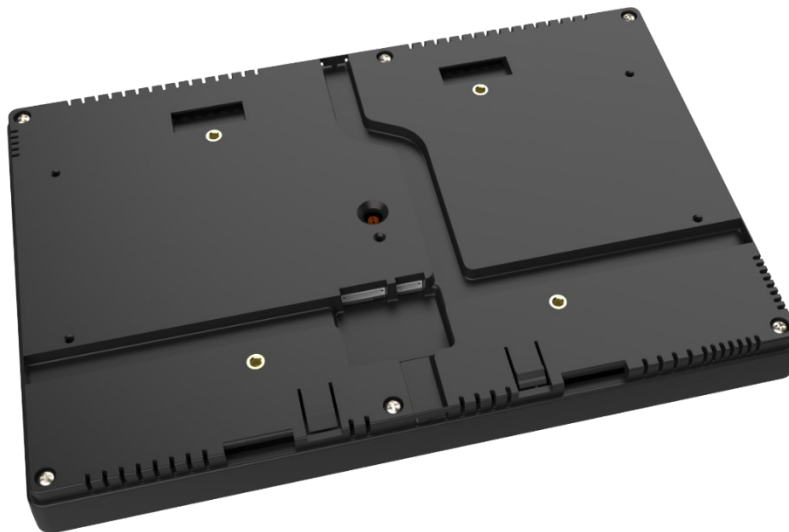

Figure 2 - Back View of IDP-1000-04A Module

3.1 PCBA Profile

The IDP-1000-04A display module is made up of four separate boards:

1. **Mainboard:** PCBA containing microprocessor and graphics controller ICs.
2. **Sensor Board:** PCBA mounted with ambient light and time-of-flight sensors.
3. **Sound Board:** PCBA containing buzzer circuit.
4. **System Indicator Boards:** 2 set of PCBAs containing diffused RGB LED chip.

The following section provides the dimensions of these PCBAs.

3.1.1 Mainboard

Dimensions of main board: 229.4mm (L) X 56.7mm (W) X 1.6mm (T) with tallest component height of approximately 4.5mm.

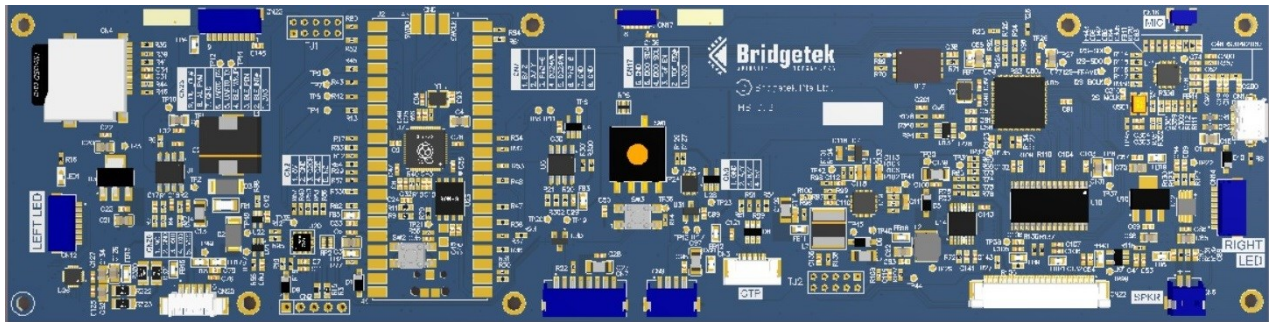

Figure 3 - Mainboard PCBA Front View

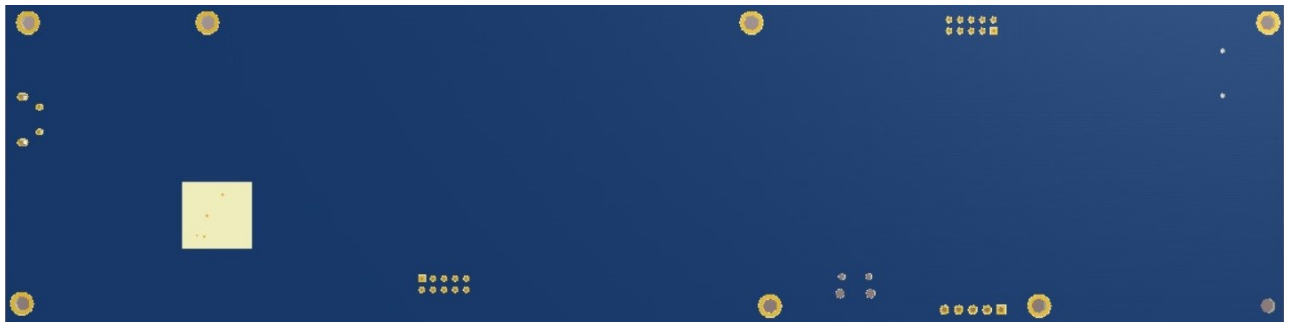

Figure 4 - Mainboard PCBA Back View

3.1.2 Sensor Board

Dimensions of sensor board: 30mm (L) X 5.5mm (W) X 1.6mm (T).



Figure 5 - Sensor Board PCBA Front View

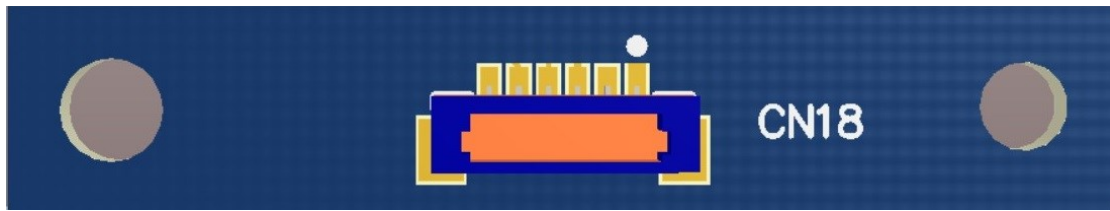

Figure 6 - Sensor Board PCBA Back View

3.1.3 Sound Board

Dimensions of sound board: 39.7mm (L) X 23.3mm (W) X 1.6mm (T).

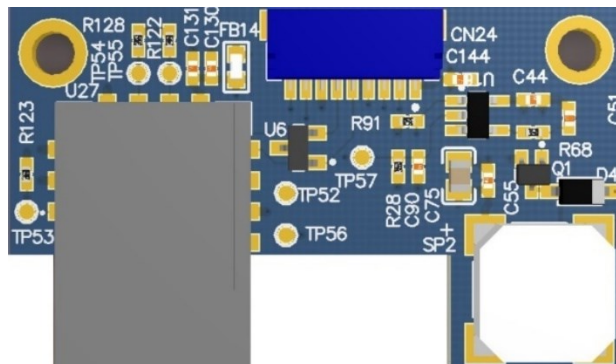

Figure 7 - Sound Board PCBA Front View



Figure 8 - Sound Board PCBA Back View

3.1.4 System Indicator Board

Dimensions of LED boards: 122.5mm (L) X 7mm (W) X 1.6mm (T).



Figure 9 - LED board PCBA- Front View



Figure 10 - LED board PCBA- Back View

3.1.5 Key Features

- ❖ 10.1-inch 1280 x (RGB) x 800 TFT-LCD panel with capacitive touch panel
- ❖ Bridgetek BT817 EVE chip for graphics, touch and audio control
- ❖ LED backlight driver integrated with 3-A, 40-V power switch
- ❖ Parallel RGB to LVDS interface converter
- ❖ Raspberry Pi RP2040 microcontroller
- ❖ 8Mbyte NOR Flash with eXecute In Place (XIP) for RP2040 firmware
- ❖ 64Mbyte NOR flash for BT817 assets
- ❖ EFM8BB110F8G-A microcontroller for ID setting verification and GPIO/function port extension
- ❖ Micro USB port for communication to RP2040 MCU (and for reprogramming Flash)
- ❖ Built-in Time-of-Flight sensor
- ❖ Built-in ambient light sensor
- ❖ Built-in system indicator LED
- ❖ Built-in audio buzzer for sound notifications
- ❖ 40-pin 0.5mm pitch FPC connector for inter-connection to LCD panel
- ❖ 10-pin 0.5mm pitch FPC connector for inter-connection to capacitive touch panel
- ❖ 6-pin 0.8mm pitch JST header for inter-connection to sensor board
- ❖ 9-pin 1mm pitch JST header for inter-connection to sound board
- ❖ 8-pin 1mm pitch JST header for inter-connection to system indicator boards
- ❖ 4-pin 1.5mm pitch JST header with RS485 interface and 5V output power supply for connection to external devices
- ❖ 8-pin 1.5mm pitch JST header with RS485 interface and 24V input power source for connection to external devices
- ❖ Micro-SD card socket
- ❖ ID switch for unique ID setting
- ❖ Bootsel button for entering USB device mode
- ❖ Hardware reset button

3.2 PCB Profile

All printed circuit boards (PCBs) in the IDP-1000-04A module are designed with four layers, stacked as follows:

1. Layer 1: Routing & Component placement (Top)
2. Layer 2: Ground Plane
3. Layer 3: Power Plane
4. Layer 4: Routing & Component placement (Bottom)

Figure 11 to Figure 18 provide the layout of these PCBs in the IDP-1000-04A module.

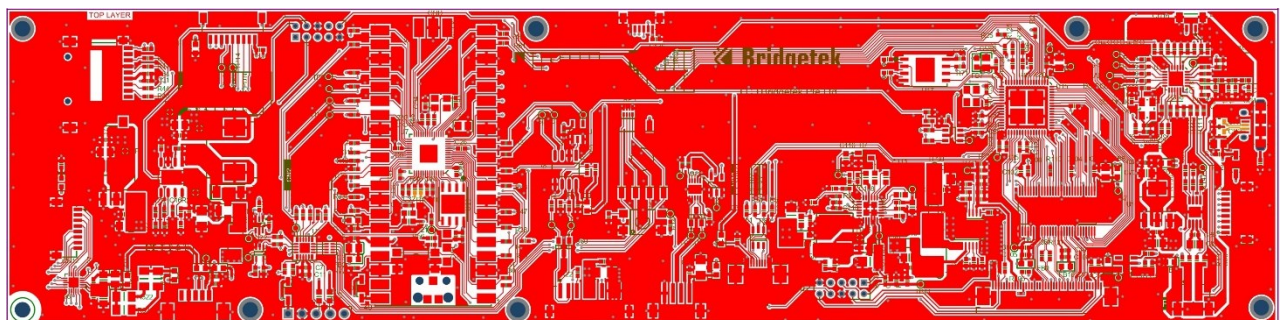

Figure 11 - Main PCB Top Layer

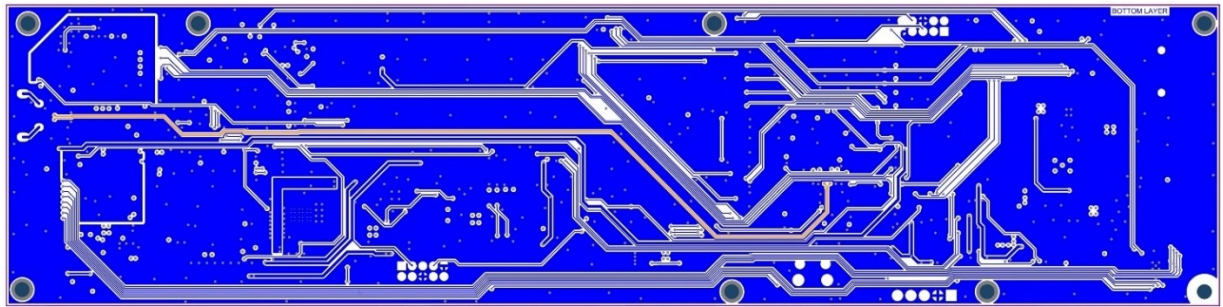

Figure 12 - Main PCB Bottom Layer



Figure 13 - Sensor PCB Top Layer



Figure 14 - Sensor PCB Bottom Layer

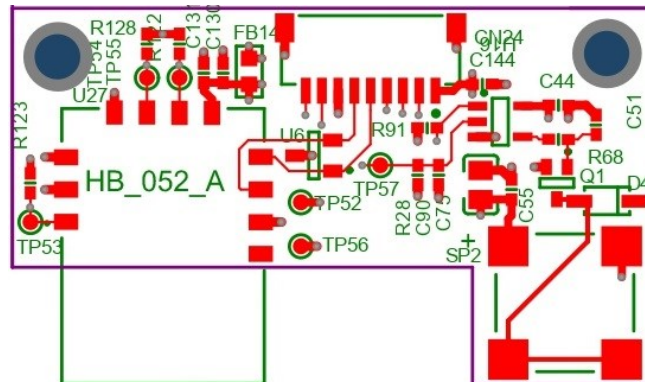

Figure 15 - Sound PCB Top Layer

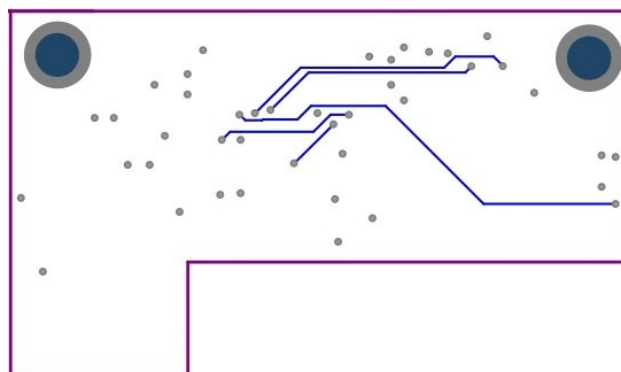

Figure 16 - Sound PCB Bottom Layer

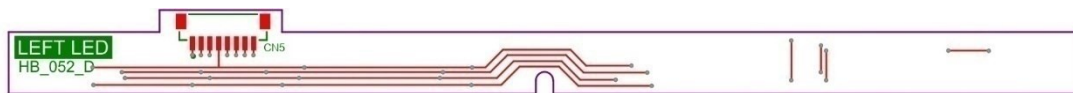

Figure 17 - LED PCB Top Layer



Figure 18 - LED PCB Bottom Layer

3.3 Connectors, Switches and Buttons

The following sections provide details about the connectors, their pin configurations, and the functions of the switches and buttons on the boards.

3.3.1 Mainboard

- **CN1 – Micro-USB Receptacle**

The micro-USB receptacle enables PC communication with RP2040 MCU and device firmware debug and updates.

- **CN3 – Capacitive Touch Panel Interface**

The 10-position 0.5mm pitch bottom contact FPC connector provides support to LCD panels with capacitive touch function.

Pin No.	Name	Type	Description
1	GND	P	Ground
2	GND	P	Ground
3	VCC3V3	P	3.3V Output power supply
4	VCC3V3	P	3.3V Output power supply
5	CTP_SCL	I	I2C serial bus, clock line
6	CTP_SDA	I/O	I2C serial bus, data line
7	CTP_RST#	O	Reset output to CTP
8	CTP_INT#	I	Interrupt input from CTP
9	GND	P	Ground
10	GND	P	Ground

Table 2 - CN3 Pinout

- **CN4 - Micro SD Card Connector**

Supports SPI communication mode with auto card detection.

- **CN7 – Input Power with RS485 Interface**

The 8-position, 1.5mm pitch right-angle JST connector provides RS485 interface to external devices and accepts 24V input power supply from external power source.

Pin No.	Name	Type	Description
1	B/Z	I/O	Negative receiver input, DE = 0; Negative driver output, DE=1
2	A/Y	I/O	Positive receiver input, DE = 0; Positive driver output, DE=1
3	NA	NA	Pin shorted to pin 6
4	DC_IN	P	24V Input power supply
5	DC_IN	P	24V Input power supply
6	NA	NA	Pin shorted to pin 3
7	GND	P	Ground
8	GND	P	Ground

Table 3 - CN7 Pinout

- **CN9 – RS485 Interface**

The 4-position, 1.5mm pitch right-angle JST connector provides RS485 interface and 5V power supply to external devices.

Pin No.	Name	Type	Description
1	GND	P	Ground
2	RFID_RS485_A/Y	I/O	Positive Receiver Input and Positive Driver Output
3	RFID_RS485_B/Z	I/O	Negative Receiver Input and Negative Driver Output
4	VDD_5V	P	5V Output power supply

Table 4 - CN9 Pinout

- **CN12 – LED Stripe Inter-Connector Left**

The 8-position, 1mm pitch right-angle JST connector functions as an interconnect header for left system indicator board, enabling control of the LED chips onboard.

Pin No.	Name	Type	Description
1	LEDA1_1	I/O	LED module control signal
2	LEDA2_1	I/O	LED module control signal
3	LEDA3_1	I/O	LED module control signal
4	LEDA4_1	I/O	LED module control signal
5	LEDB1_1	I/O	LED module control signal
6	LEDB2_1	I/O	LED module control signal
7	LEDB3_1	I/O	LED module control signal
8	LEDB4_1	I/O	LED module control signal

Table 5 - CN12 Pinout

- **CN14 – System indicator Inter-Connector Right**

The 8-position, 1mm pitch right-angle JST connector functions as an interconnect header for right system indicator board, enabling control of the LED chips onboard.

Pin No.	Name	Type	Description
1	LEDC4_1	I/O	LED module control signal
2	LEDC3_1	I/O	LED module control signal
3	LEDC2_1	I/O	LED module control signal
4	LEDC1_1	I/O	LED module control signal
5	LEDB4_1	I/O	LED module control signal
6	LEDB3_1	I/O	LED module control signal
7	LEDB2_1	I/O	LED module control signal
8	LEDB1_1	I/O	LED module control signal

Table 6 - CN14 Pinout

- **CN17 – Sensor Board Inter-Connector**

The 6-position, 0.8mm pitch right-angle JST connector functions as an interconnect header for sensor board, providing I2C interface from RP2040 MCU to ambient light and Time of Flight (ToF).

Pin No.	Name	Type	Description
1	VDD_3V3	P	3.3V Output power supply
2	TOF_IRQ#	I	Interrupt input from ToF sensor, open drain.
3	TOF_EN	O	Enable output to ToF sensor
4	I2C0_SCL	O	I2C serial bus, clock line
5	I2C0_SDA	I/O	I2C serial bus, data line
6	GND	P	Ground

Table 7 - CN17 Pinout

- **CN22 – LVDS LCD Panel Interface**

This 40-position, 0.5mm pitch top-contact FPC connector from TE Connectivity is used for inter-connection to the 10.1" LVDS LCD panel. The manufacturer's part number for this connector is "4-1734839-0."

Pin No.	Name	Type	Description
1	VCOM	P	Common voltage
2	VDD_LCD	P	Power Supply, 2.5V output voltage
3	VDD_LCD	P	Power Supply, 2.5V output voltage
4	NC	NA	No Connection
5	NC	NA	No Connection
6	NC	NA	No Connection
7	GND	P	Ground
8	TX0_N	O	LVDS TX data bit 0 differential N signal
9	TX0_P	O	LVDS TX data bit 0 differential P signal
10	GND	P	Ground
11	TX1_N	O	LVDS TX data bit 1 differential N signal
12	TX1_P	O	LVDS TX data bit 1 differential P signal
13	GND	P	Ground
14	TX2_N	O	LVDS TX data bit 2 differential N signal
15	TX2_P	O	LVDS TX data bit 2 differential P signal
16	GND	P	Ground
17	TXCLK_N	O	LVDS TX clock differential N signal
18	TXCLK_P	O	LVDS TX clock differential P signal
19	GND	P	Ground
20	TX3_N	O	LVDS TX data bit 3 differential N signal
21	TX3_P	O	LVDS TX data bit 3 differential P signal
22	GND	P	Ground
23	NC	NA	No connection
24	NC	NA	No connection
25	GND	P	Ground
26	NC	NA	No connection
27	BL_PWM	O	Output PWM signal
28	NC	NA	No connection
29	LCD8V	P	Power for analog circuit, 8.2V output
30	GND	P	Ground

31	LEDK	P	LED Cathode
32	LEDK	P	LED Cathode
33	NC	NA	No connection
34	NC	NA	No connection
35	VGL	P	Gate OFF Voltage, -7V output voltage
36	NC	NA	No connection
37	DISP	O	LCD Enable output
38	VGH	P	Gate ON Voltage, 21.8V output voltage
39	LEDA	P	LED Anode
40	LEDA	P	LED Anode

Table 8 - CN22 Pinout

- **CN23 – Sound Board Inter-Connector**

This 9-position, 1 mm pitch right-angle JST connector acts as an interconnect header for the sound board, enabling system notification functionality from BT817 EVE. The connector also incorporates UART interface and GPIO control from the EFM8BB1 microcontroller's multifunction I/O ports for devices such as BLE module.

Pin No.	Name	Type	Description
1	VDD_3V3	P	3.3V Output power supply
2	BLE_INT#	I/O	Not in use
3	BLE_PDN	I/O	Not in use
4	BLE_WKUP	I/O	Not in use
5	UART0_TXD	I/O	Not in use
6	UART0_RXD	I/O	Not in use
7	GND	P	Ground
8	AL_PWM	O	BT817 EVE sigma-delta audio output
9	BUF_OE#	I/O	BT817 EVE GPIO2

Table 9 - CN23 Pinout

3.3.2 System Indicator Board

- **CN5 – LED Strip Connector Left**

This 8-position 1mm pitch right angle JST connector serves as interconnect header to mainboard.

Pin No.	Name	Type	Description
1	LEDA11	I/O	LED module control signal
2	LEDA21	I/O	LED module control signal
3	LEDA31	I/O	LED module control signal
4	LEDA41	I/O	LED module control signal
5	LEDB11L	I/O	LED module control signal
6	LEDB21L	I/O	LED module control signal
7	LEDB31L	I/O	LED module control signal
8	LEDB41L	I/O	LED module control signal

Table 10 - CN5 Pinout

- **CN13 – LED Strip Connector Right**

This 8-position 1mm pitch right angle JST connector serves as interconnect header to mainboard.

Pin No.	Name	Type	Description
1	LEDC41	I/O	LED module control signal
2	LEDC31	I/O	LED module control signal
3	LEDC21	I/O	LED module control signal
4	LEDC11	I/O	LED module control signal
5	LEDB41L	I/O	LED module control signal
6	LEDB31L	I/O	LED module control signal
7	LEDB21L	I/O	LED module control signal
8	LEDB11L	I/O	LED module control signal

Table 11 - CN13 Pinout

3.3.3 Sensor Board

- **CN18 – Sensor Board Connector**

This 6-position, 0.8mm pitch right-angle JST connector functions as an interconnect header to main board.

Pin No.	Name	Type	Description
1	VDD_3V3	P	3.3V Output power supply
2	TOF_IRQ#	O	Interrupt output from sensor, open drain.
3	TOF_EN	I	Input for enabling ToF sensor
4	I2C0_SCL	I	I2C serial bus, clock line
5	I2C0_SDA	I/O	I2C serial bus, data line
6	GND	P	Ground

Table 12 - CN18 Pinout

3.3.4 Sound Board

- **CN24 – Sound Board Inter-Connector**

This 9-position, 1mm pitch right-angle JST connector as an interconnect header to main board.

Pin No.	Name	Type	Description
1	OFB_VDD_3V3	P	3.3V Output power supply
2	OFB_BLE_INT#	NA	Not in use
3	OFB_BLE_PDN	I	Not in use
4	OFB_BLE_WKUP	I	Not in use
5	OFB_UART0_TXD	I	Not in use
6	OFB_UART0_RXD	O	Not in use
7	GND	P	Ground
8	OFB_AL_PWM	O	Output PWM signal
9	OFB_BUF_OE#	I	Control for buffer enable and buzzer mute

Table 13 - CN24 Pinout

3.3.5 Switches and Buttons

- **SW1** is a 10-position rotary switch use for configuring a unique ID for the module.
- **SW2** is the BOOTSEL button to put RP2040 MCU into programming mode to program firmware into the 8MB flash memory connected to QSPI bus.
- **SW3** is hardware reset button to reset RP2040 MCU.

4 Board Schematics

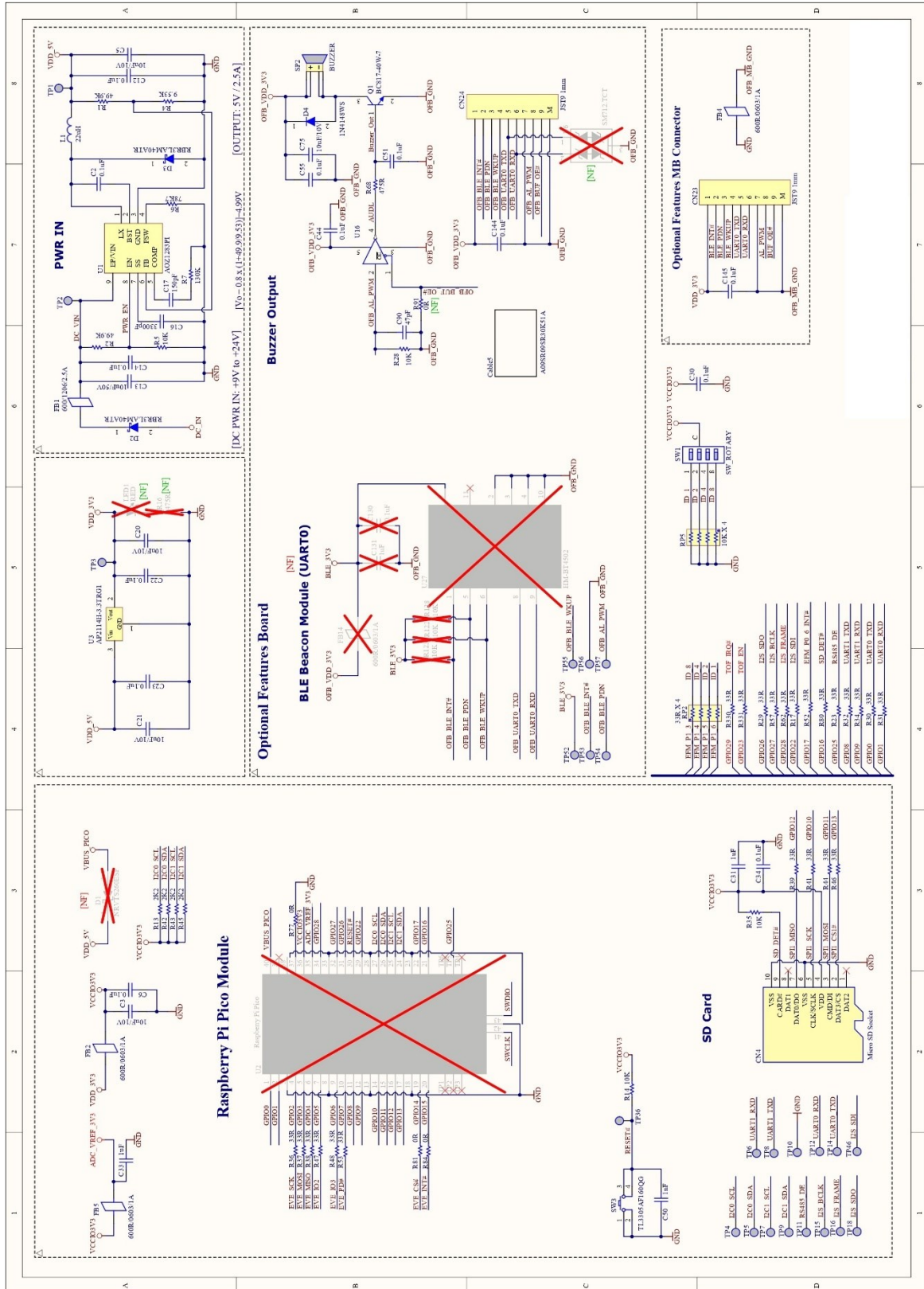

Figure 19 - Main board Power circuit & Sound board

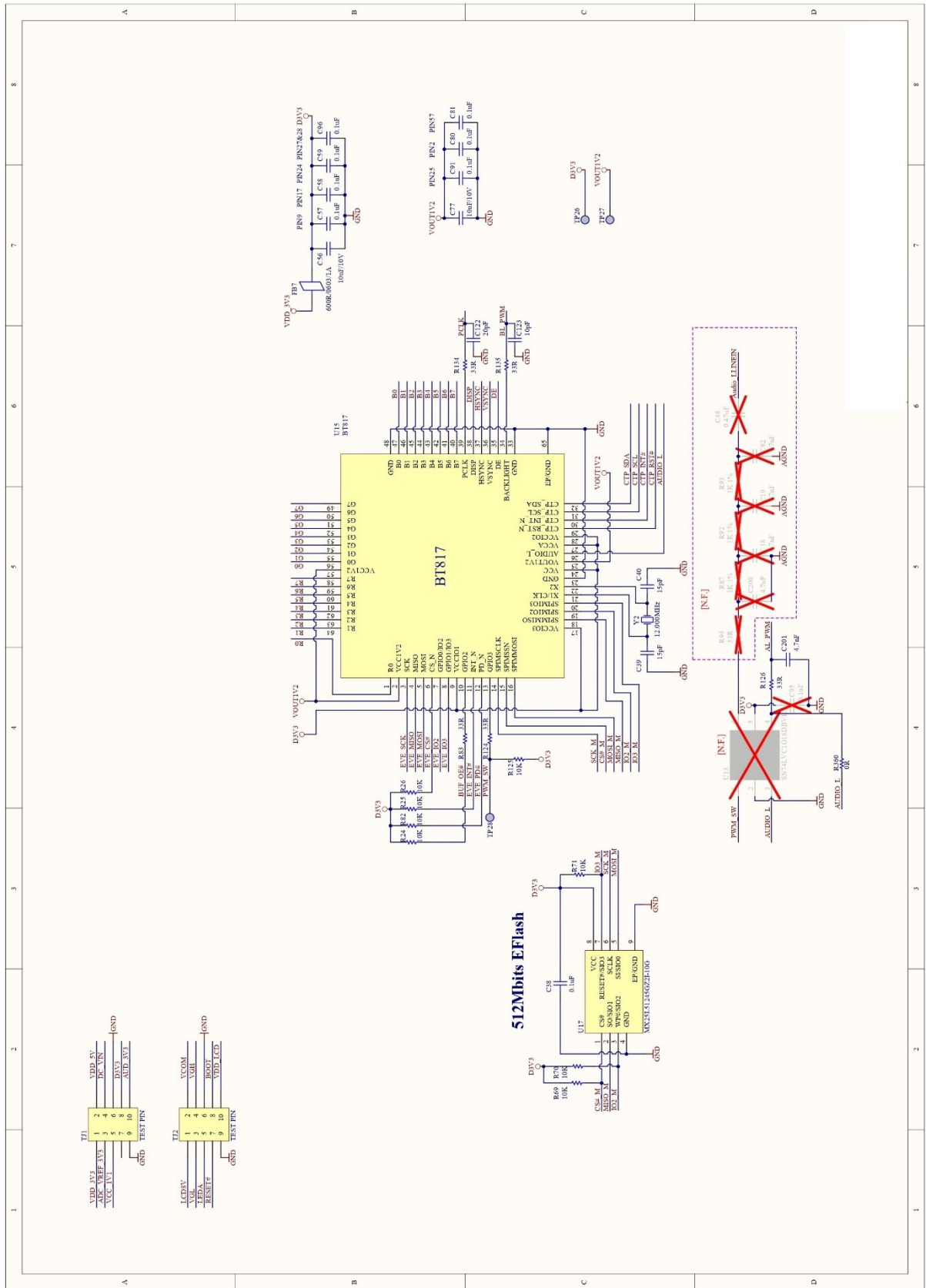

Figure 20 - BT817 EVE Graphic Controller

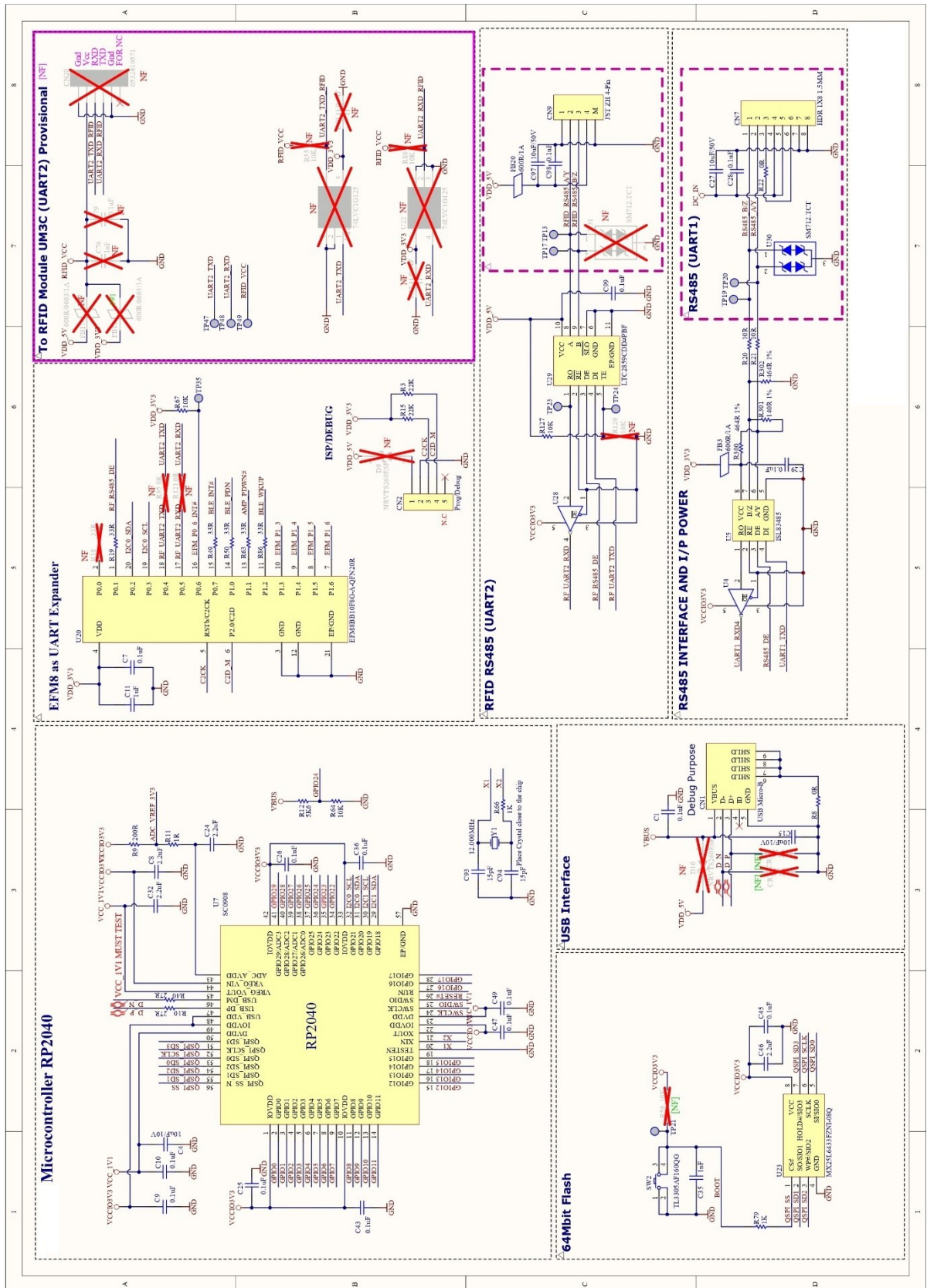

Figure 21 - RP2040 Microcontroller

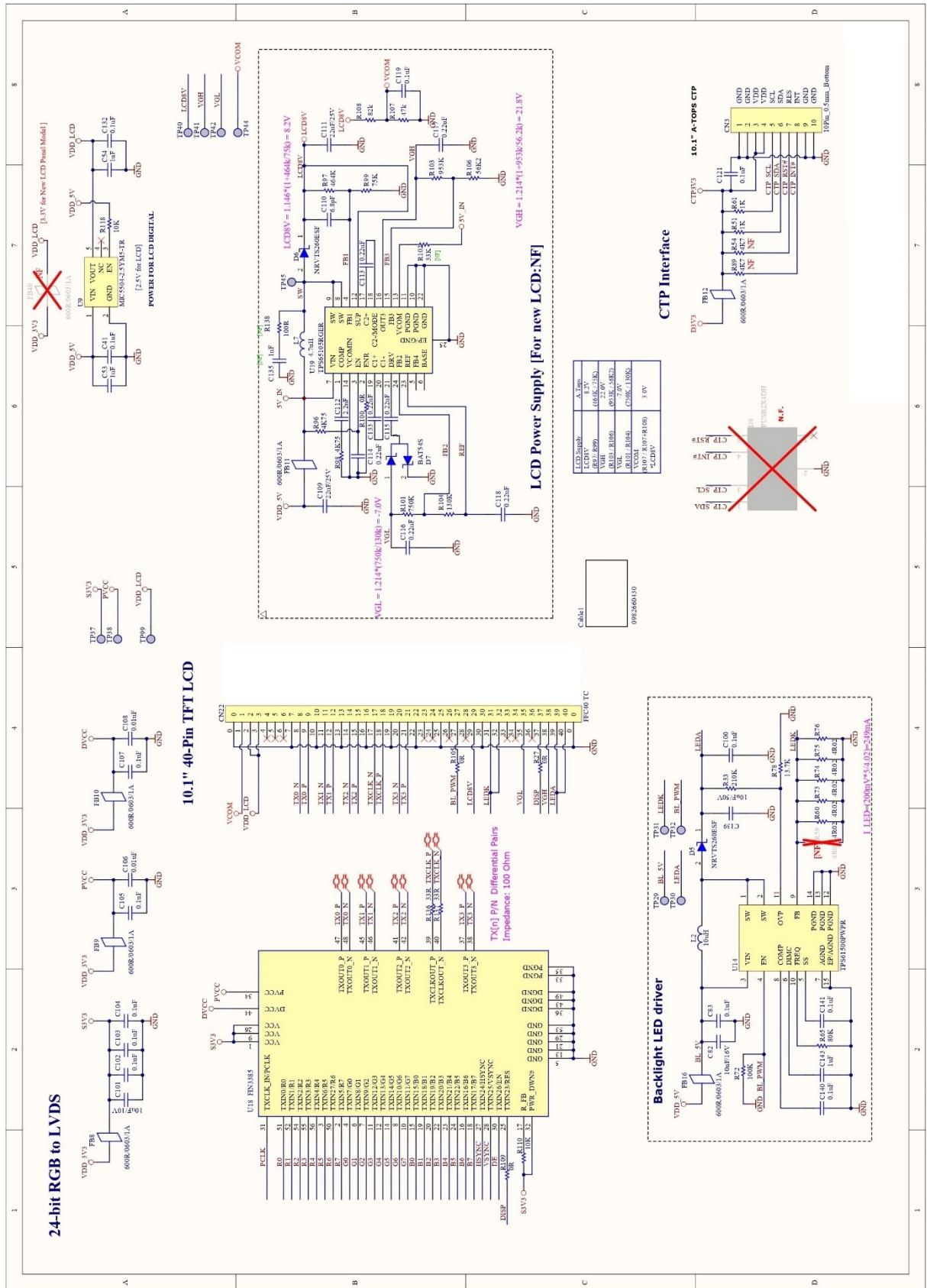

Figure 22 - RGB to LVDS Conversion

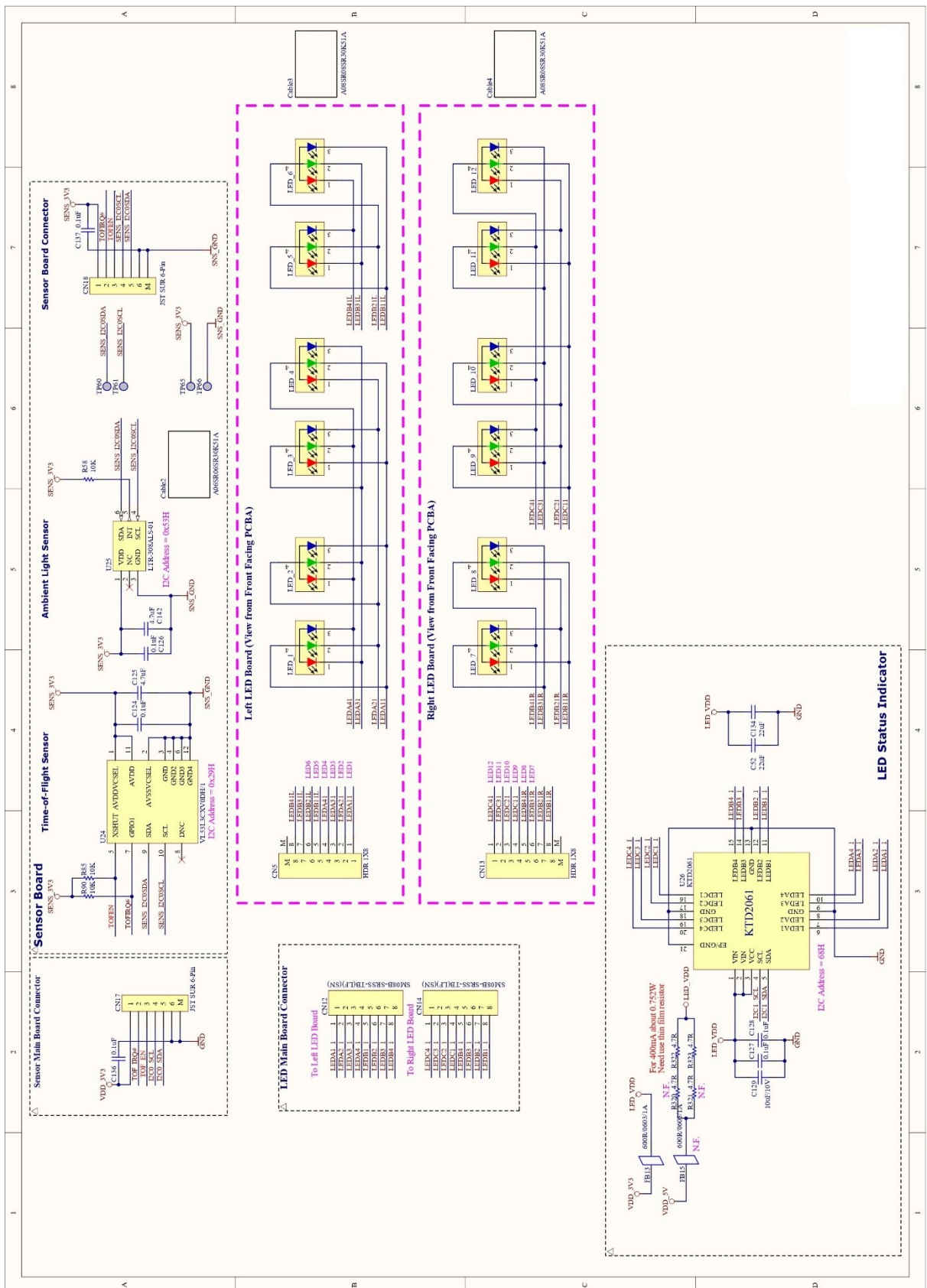

Figure 23 - Sensors and LED Strip

5 Device Description and Configuration

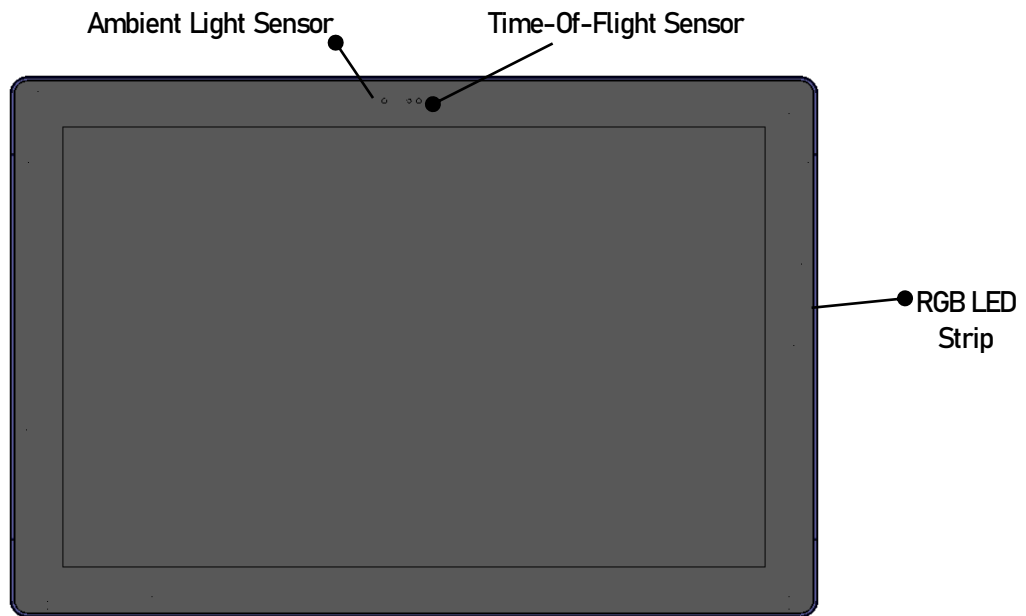

Figure 24 - IDP-1000-04A Display Front View

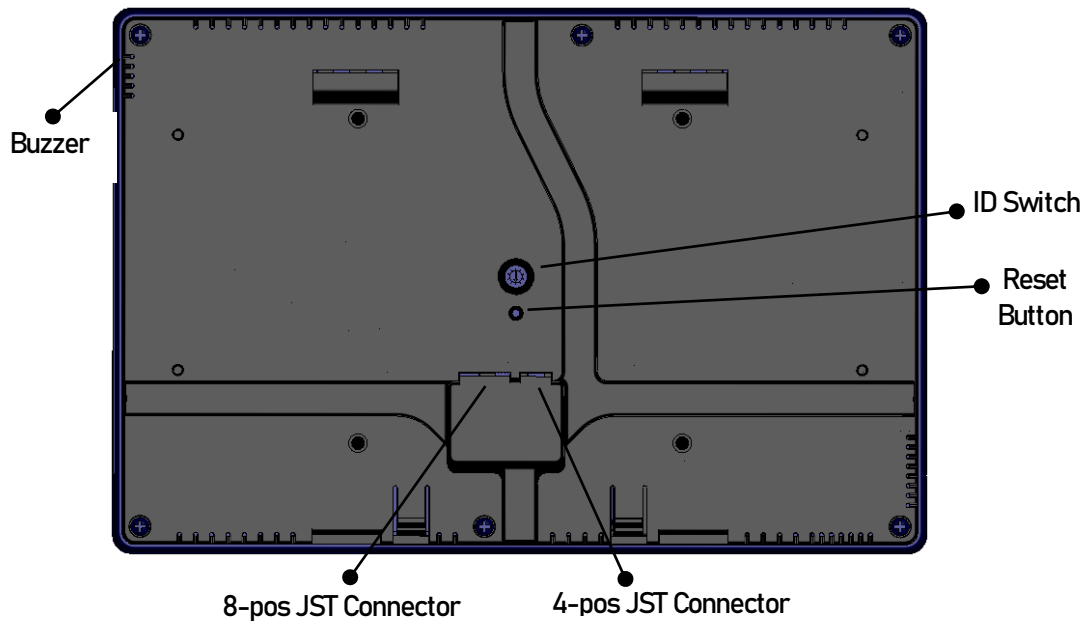

Figure 25 - IDP-1000-04A Display Rear View

5.1 Power Supply

Power is delivered through the JST8 port located on the back of the IDP-1000-04A display module. The supply voltage is 24V DC, with a nominal operating current of approximately 300mA. Users are advised to use a 12W power source.

5.2 Microcontroller

Raspberry Pi RP2040 microcontroller unit used in the module has the following key features:

- Dual ARM Cortex-M0+ @ 133MHz
- 264kB on-chip SRAM in six independent banks
- Support 8MB of on-board Flash memory via dedicated QSPI bus
- Micro-USB port supporting USB2.0 Full-speed device function; reprogramming the Flash can be achieved by simply dragging and dropping a file onto the RP2040 which appears as a mass storage device.
- 26 multi-function 3.3V General Purpose I/O (GPIO) with 23 GPIOs being digital-only and 3 ADC-capable GPIOs.
- 3-pin ARM Serial Wire Debug (SWD) port; the standard Serial Wire Debug (SWD) port can reset the system and load and run code without any button presses as well as for debugging purpose.

For full details of the Raspberry Pi RP2040 MCU, please refer to the [RP2040 Datasheet](#).

5.3 Graphic Controller

The IDP-1000-04A utilizes Bridgetek’s fourth-generation Advanced Embedded Video Engine (EVE) BT817, offering high-resolution graphics and video playback to create high-quality Human Machine Interfaces (HMIs). In addition to graphics, it supports touch screen interface and features sigma delta audio out.

5.4 8-position JST Connector

Power and data are provided through the 8-position JST connector located at the rear of the display module, which interfaces with an external host controller via RS485. The product package includes a JST8-RJ45 cable for connecting the display module to external devices.

Figure 26 and Table 14 illustrates the pin orientation and functions of the 8-position JST connector.

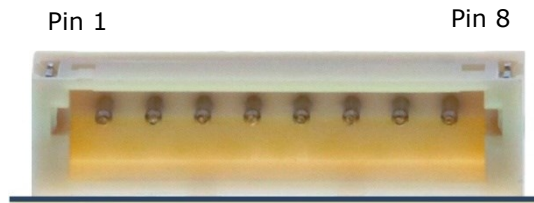

Figure 26 - JST8 Port Pin Orientation

Pin Number	1	2	3, 6	4, 5	7, 8
Function	RS485 B/Z	RS485 A/Y	Pins Connected	DC24V IN	GND

Table 14 - JST8 Port Pin Function

5.5 4-position JST Connector

The 4-position JST connector is intended for connecting to external devices that utilize the RS485 interface. In addition to data connectivity, the connector also supplies DC5V power.

Figure 27 and Table 15 illustrates the pin orientation and functions of the 4-position JST connector.

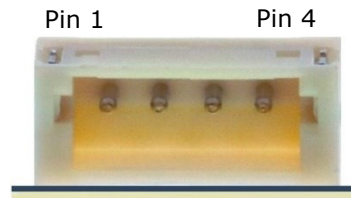

Figure 27 - JST4 Port Pin Orientation

Pin Number	1	2	3	4
Function	GND	RS485 A/Y	RS485 B/Z	DC5V (Output)

Table 15 - JST4 Port Pin Function

5.6 Reset Button

The IDP-1000-04A module includes a built-in device reset function. The reset button is located at the rear of the display module, beneath the rotary ID switch, and can be activated by pressing through the hole.

5.7 ID Switch

The ID switch on the back of the display can be configured with custom settings or left at the factory default value of zero. It is useful for device management in scenarios involving multiple devices or the configuration of boot modes.

5.8 Buzzer

The IDP-1000-04A display module includes an integrated buzzer circuit for event notifications.

5.9 Time-of-Flight Sensor

The IDP-1000-04A features an integrated time-of-flight sensor, controlled by the RP2040 MCU via I2C communication, enabling the device to detect objects or people from a distance of up to 1.5 meters. This feature is useful for waking the module from screen sleep mode when a person approaches.

5.10 Ambient light Sensor

With its built-in ambient light sensor, controlled by the RP2040 MCU via I2C communication, the module can automatically adjust the screen brightness based on the surrounding light conditions.

5.11 LED Indicator

Two RGB LED strips are positioned on the left and right sides of the device, serving as an RGB matrix indicator for the system status. Customers can customize the LED colors and behavior through the firmware and upload it to the MCU.

5.12 JST8-RJ45 Cable

A 5-meter JST8-RJ45 cable, which functions as both the input supply source and RS485 interface to the external host, will be included in the package. One end of the cable consists of a JST 1.5mm 8-position receptacle while the other end is fitted with a standard RJ45 plug.

Figure 28 and Table 16 illustrates the pin orientation and functions of the JST receptacle and RJ45 plug.

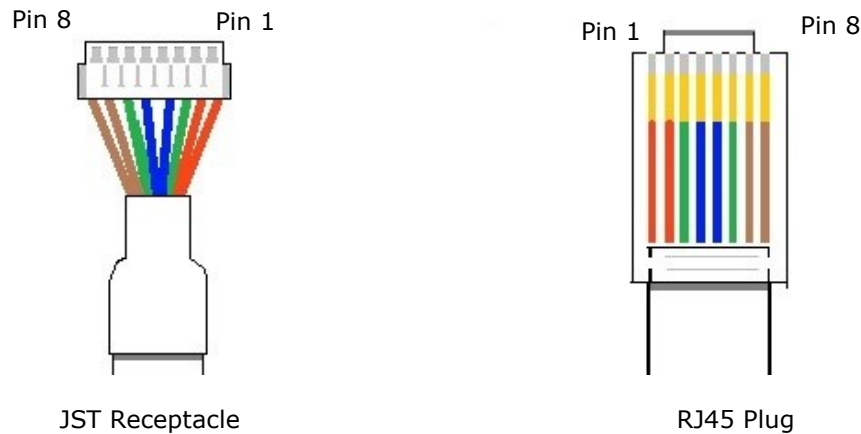

Figure 28 - JST8-RJ45 Cable Pin Orientation

Pin Number	1	2	3, 6	4, 5	7, 8
Function	RS485 B/Z	RS485 A/Y	Detection	DC24V IN	GND

Table 16 - JST8-RJ45 Cable Pin Definition

The JST receptacle connects to the IDP-1000-04A module, facilitating communication with an external host and receiving power from it. The RJ45 cable links to the external host, enabling both data transmission and power delivery. Other than incorporating an RJ45 socket with integrated power source in their design, developers can also achieve this by using a widely available Power-over-Ethernet (PoE) splitter. Below are some PoE splitters purchase link from global distributor/ online marketplace:

- [PoE Splitter - Digikey](#)
- [PoE Splitter- AliExpress](#)

Please refer to Figure 29 for connection while using the PoE splitter.

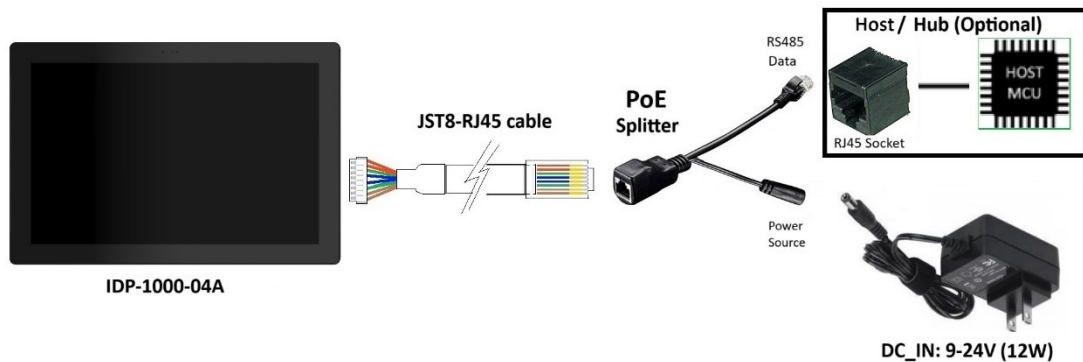

Figure 29 - IDP-1000-04A Connection to Host with Use of PoE Splitter

Note: PoE splitter and DC power adapter not included in package.

6 Specifications

6.1 Electrical Specifications

Parameter		Min	Typ	Max	Unit
DC_IN	Input voltage range	9	24.0	28	V
VDD_5V	Output voltage range	4.75	5.0	5.25	V
Icc_24V	Operating current, DC_IN=24V: Normal Operating current, DC_IN=24V: Screen Timeout	- -	310 135	- -	mA
V _{OD1}	Driver Differential V _{OUT} (no load)	-	-	3.3	V
V _{OD2}	Driver Differential V _{OUT} (with load) R _L =100Ω (RS-422) (Figure 30) R _L = 54Ω (RS-485) (Figure 30) R _L = 60Ω, -7V ≤ V _{CM} ≤ 12V	2 1.5 1.5	2.7 2.3 2.6	- 3.3 -	V
ΔV _{OD}	Change in Magnitude of Driver Differential V _{OUT} for Complementary Output States R _L = 54Ω or 100Ω (Figure 30)	-	0.01	0.2	V
V _{OC}	Driver Common-Mode V _{OUT} R _L = 54Ω or 100Ω (Figure 30)	-	1.8	3	V
ΔV _{OC}	Change in Magnitude of Driver Common-Mode V _{OUT} for Complementary Output States R _L = 54Ω or 100Ω (Figure 30)	-	0.01	0.2	V
Temperature	Operating temperature Storage temperature	0 0	- -	50 60	°C

Table 17 - Operating Voltage and Current

Test Circuits

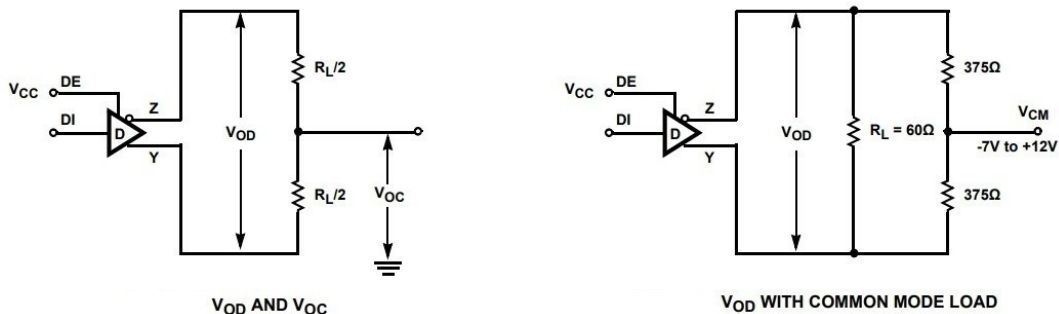

Figure 30 - DC Driver Test Circuits

6.2 Optical Specifications

Item	Symbol	Condition	Min.	Typ.	Max.	Unit	
Brightness	Bp	$\theta=0^\circ$ $\Phi=0^\circ$	-	700	-	Cd/m ²	
Uniformity	Δ Bp		70	80	-	%	
Viewing Angle	3:00	$Cr \geq 10$	-	80	-	Deg	
	6:00		-	80	-		
	9:00		-	80	-		
	12:00		-	80	-		
Contrast Ratio	Cr	$\theta=0^\circ$ $\Phi=0^\circ$	600	800	-	-	
Response Time	Tr + Tf	$\theta=0^\circ$ $\Phi=0^\circ$	-	25	50	ms	
Color of CIE Coordinate	W	x	$\theta=0^\circ$ $\Phi=0^\circ$	Typ -0.05	Typ +0.05	-	
		y				-	
	R	x				0.290	-
		y				0.358	-
	G	x				0.589	-
		y				0.323	-
	B	x				0.330	-
		y				0.578	-
S	x	0.146	-				
	y	0.140	-				
NTSC Ratio	S		40	50	-	%	

Table 18 - Optical Specifications

Note: The parameter is slightly changed by temperature, driving voltage and material.

7 Mechanical Dimensions

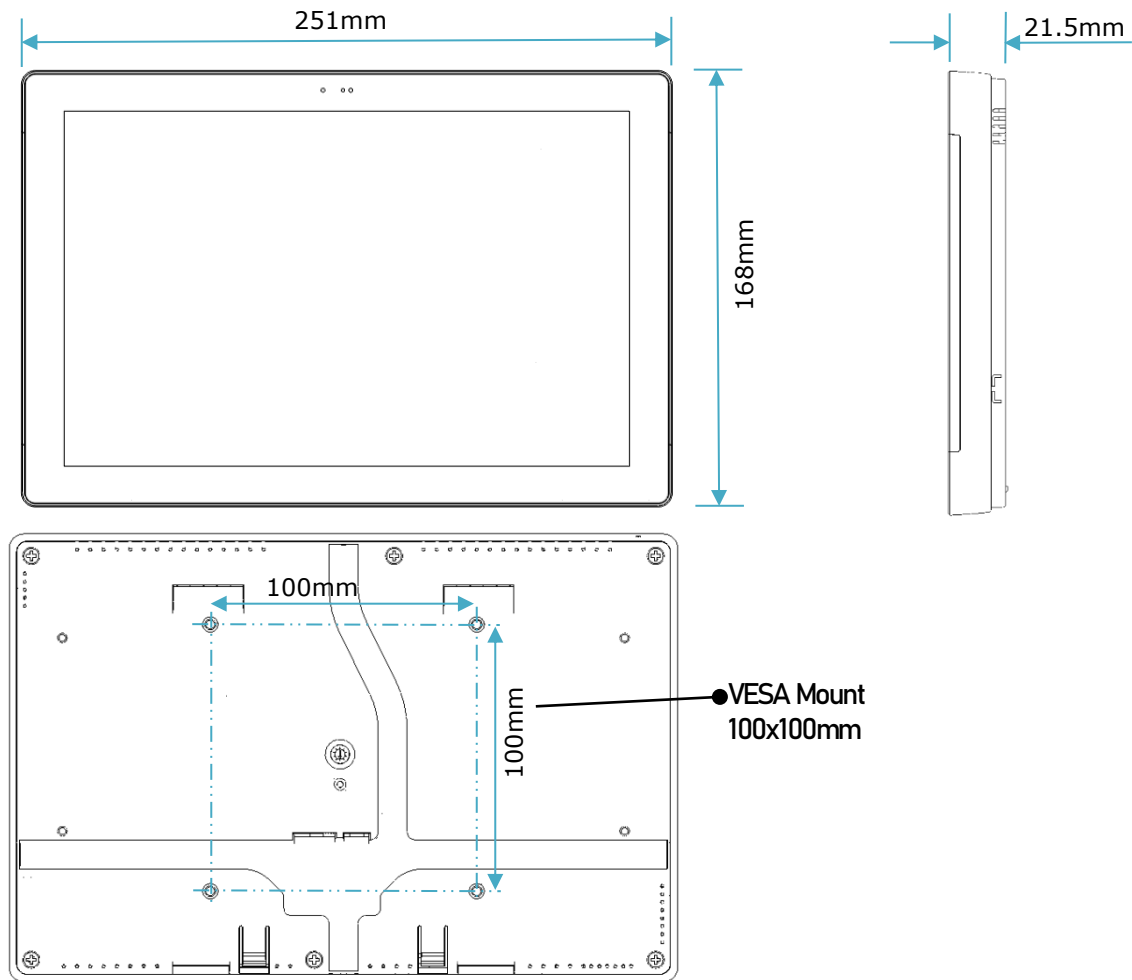

Figure 31 - IDP-1000-04A Display Dimensions

Figure 32 shows the locations of the panel mount metal bracket drill holes, referenced from the center of the device.

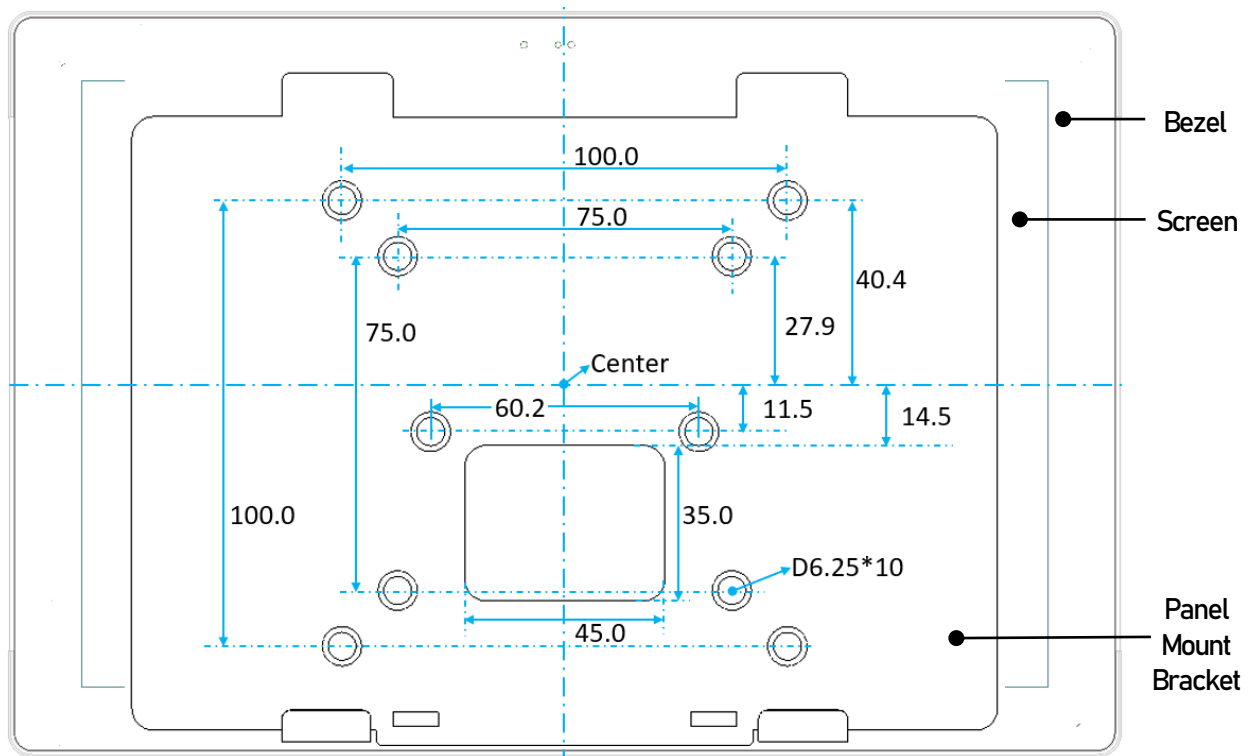

Figure 32 - Panel Mount Bracket Drill Holes Drawings (Front View)

Note: All dimensions are in millimeters.

8 Package Contents, Mounting and Disassembly Guide

The following section provides details on the contents of the IDP-1000-04A package, the device mounting process and the disassembly of the display module for firmware downloading.

8.1 Package content

Table 19 below lists the contents included in the IDP-1000-04A package.

Sl. No.	Description	Quantity
IDP-1000-04A Display Module		
1	Display module	1
Mounting Accessories		
2	Wall Box Mounting Bracket	1
3	Glass mount cover sheet	1
4	Double sided tape for Glass mount	2
Cable		
5	RJ45 to JST8 cable, 5-meter	1

Table 19 - Package Contents

8.2 Mounting Guide

The IDP-1000-04A package includes accessories designed to facilitate the mounting of the display module and connecting it to external devices. It supports four mounting options:

1. Wall mount
2. Electrical Box mount
3. Glass mount
4. VESA mount

Figure 33 to Figure 37 demonstrates these mounting options.

The following are the different mounting options available for the IDP-1000-04A.



Figure 33 - Wall Mount



Figure 34 - Electrical Junction Box Mount

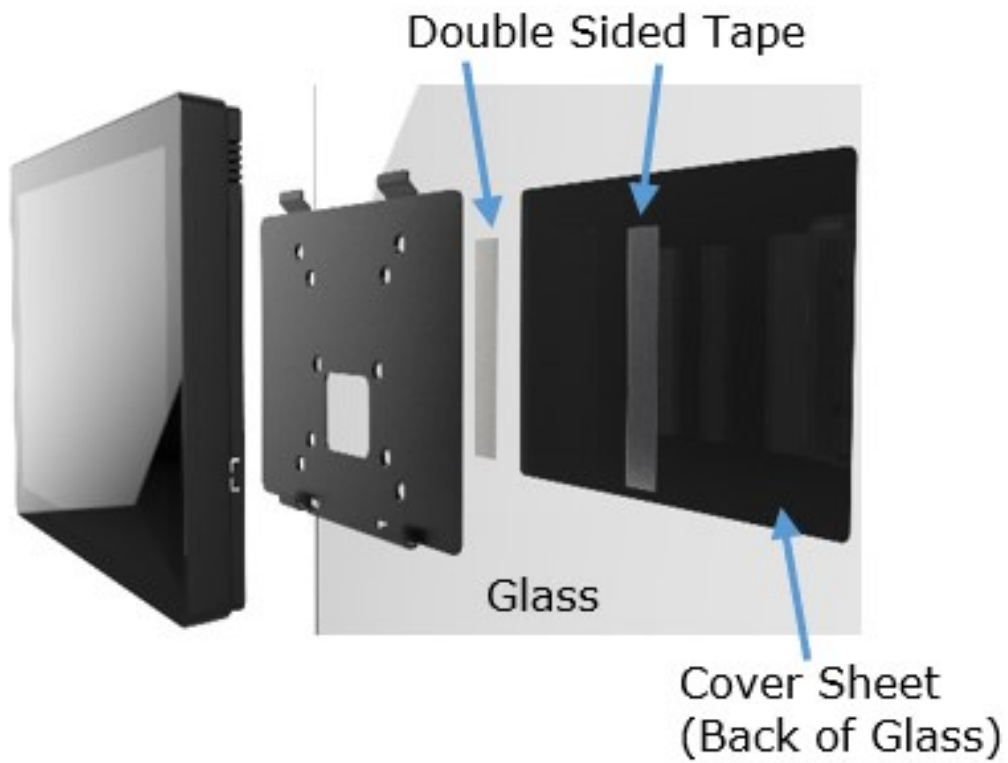

Figure 35 - Glass Mount



Figure 36 - VESA Mount (100X100)

Figure 37 illustrates the cable wiring direction options for the wall mount and glass mount (Rear View). The cable can pass through the rectangle slot of the Panel Mount Bracket for the electrical mount and VESA mount in addition to the options below. (Refer to Figure 32)

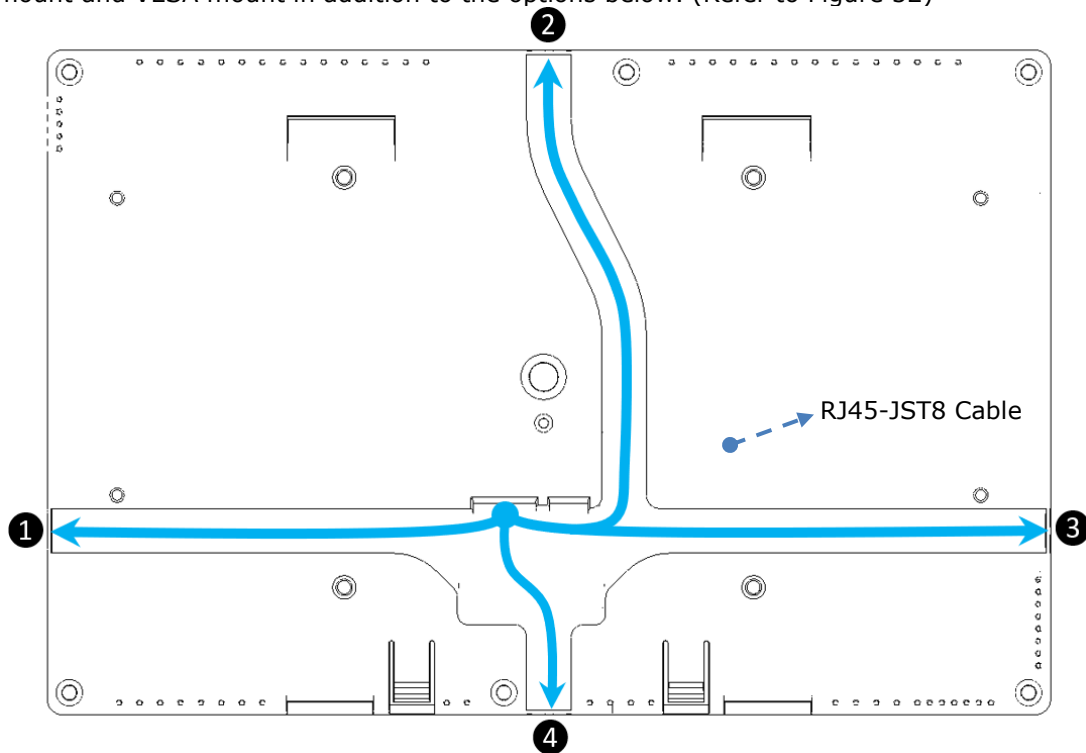

Figure 37 - RJ45-JST8 Cable Wiring Direction Options

Note:

A 5-meter RJ45-JST8 cable is included in the package with the following dimensions:

- Cable: 5m (L) x 9.1mm (W) x 3.0mm (T)
- RJ45 plug: 22mm (L) 11.5mm (W) x 13mm (T) .
- JST 8 plug: 14mm (L) x 4.5 (H) x 3.5 mm (T)

8.3 Disassembly Guide

This section outlines the disassembly process for the display module to facilitate firmware downloading.

The back cover of the display module can be easily removed by unscrewing six 3mm screws from the locations indicated in Figure 38.

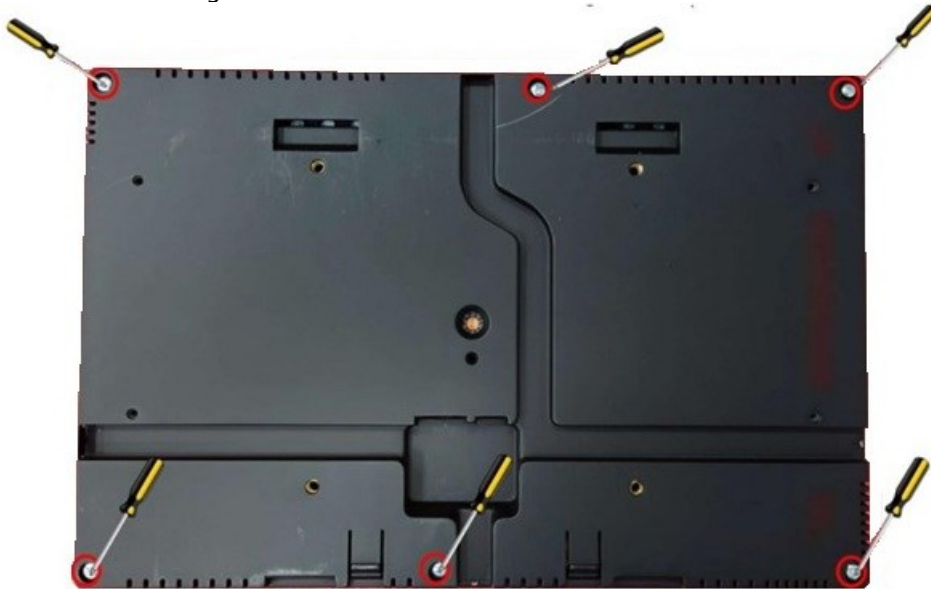

Figure 38 - Remove screws to detach back cover

Once the back cover is removed, the main board and speaker board will be directly accessible.

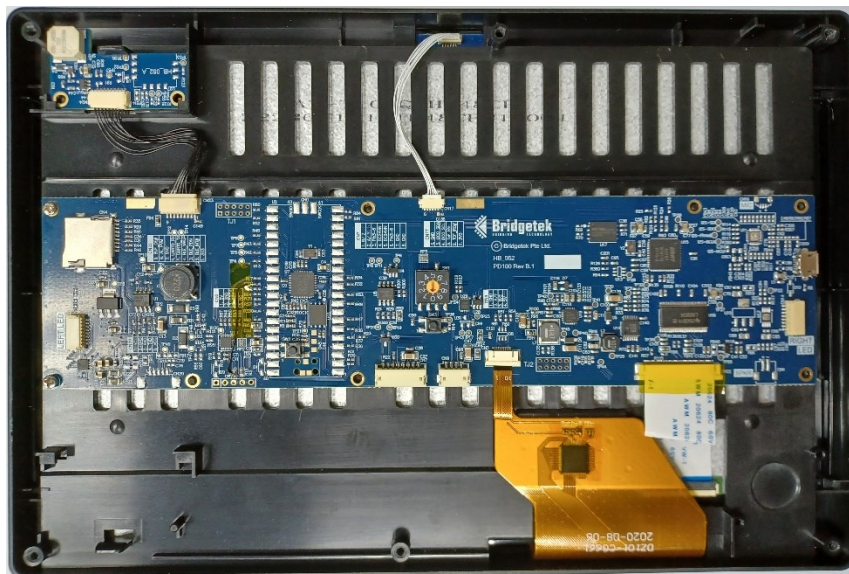

Figure 39 - Main PCBA and Speaker Board

Figure 40 indicate locations of debugging connectors and buttons commonly used by developers.

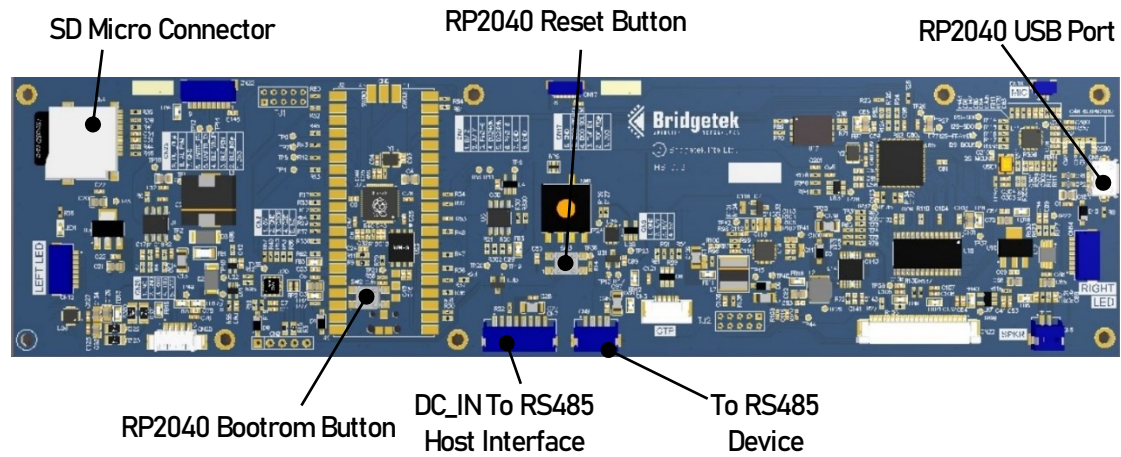

Figure 40 - Debugging and Commonly Use Connectors

9 Software Setup Information

9.1 Startup Test

The device comes preloaded with default firmware stored in the integrated XIP NOR-Flash. Follow these steps to perform an initial test of the set before flashing developers' own code.

Step 1: Powering Up the Device

Connect the device to power using the provided cable via the JST8 connector at DC_IN. For details, refer to section 5.1 and 5.12.

Step 2: Touch Calibration

When powered on, the display module's preloaded firmware will prompt the user to perform a touch calibration test, as shown in Figure 41. During calibration process, an audible beep tone will be activated. Complete the calibration as required for the application.

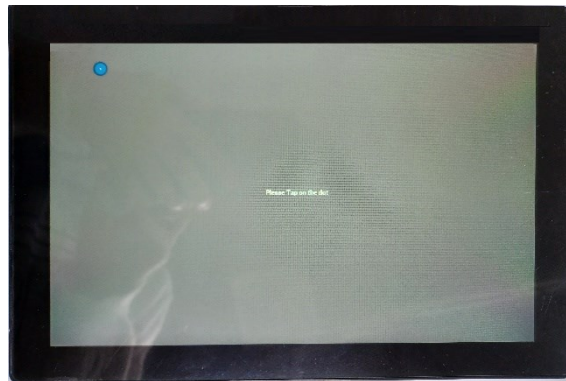

Figure 41 - Touch Calibration

Once the CTP is successfully calibrated, the **Bridgetek** company logo will be displayed.



Figure 42 - Bridgetek Logo

Conducting this startup test ensures the device is operational before developers load their custom code.

9.2 Downloading Firmware

For firmware development, Bridgetek provides various development tools and sample codes to assist in the process. Refer to Section 9.3 for more details. The following methods outline the procedure for downloading the developer's firmware once it is ready.

The developer's firmware can be downloaded into the 64Mbit XIP NOR-Flash attached to the RP2040 Raspberry Pi MCU via the USB Micro connector connected to the MCU.

There are two ways to enter **USB boot mode** for downloading the developer's firmware:

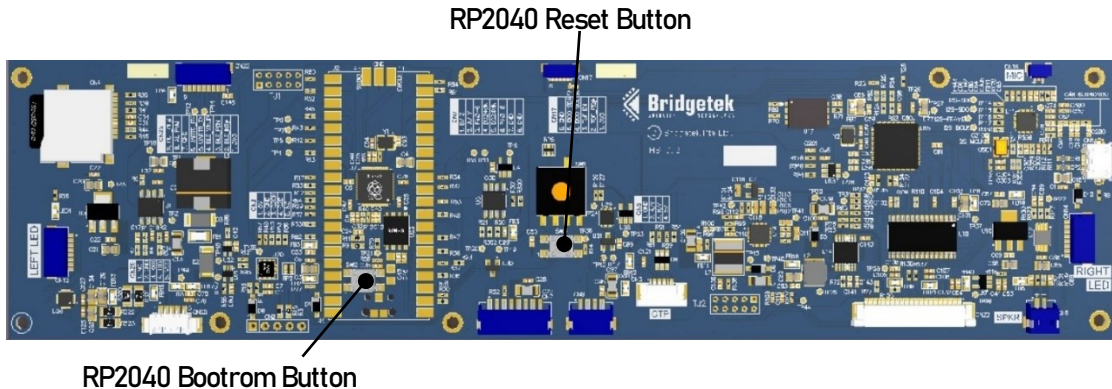

Figure 43 - Downloading Developer's Firmware

- **Method 1:** Press and hold the **Bootrom** button while powering up the display module.
- **Method 2:** While the unit is powered on, press and hold the **Bootrom** button, then press and release the **Reset** button before finally releasing the **Bootrom** button.

For detailed instructions on downloading the firmware, please refer to Section 9.3.

9.3 Software Development Tools and Support

Bridgetek provides free, comprehensive software to help users develop applications with ease. For more information, please visit the following web portal:

<https://github.com/Bridgetek/IDP-1000-04A>

10 Disclaimer Notice: Use of Third-Party Software or Websites

We may recommend use of software or web sites that are owned or operated by other companies. We offer or facilitate this recommendation by hyperlinks or other methods to aid your access to the third-party resource. While we endeavour to direct you to helpful, trustworthy resources, we cannot endorse, approve, or guarantee software, information, products, or services provided by or at a third-party resource or track changes in the resource. Thus, we are not responsible for the content or accuracy of any third-party resource or for any loss or damage of any sort resulting from the use of, or for any failure of, products or services provided at or from a third party resource.

We recommend these resources on an "as is" basis. When you use a third party resource, you will be subject to its terms and licenses and no longer be protected by our privacy policy or security practices, which may differ from the third policy or practices or other terms. You should familiarize yourself with any license or use terms of, and the privacy policy and security practices of, the third party resource, which will govern your use of that resource.

11 Warranty Statement

According to our after-sales policy, the warranty (if applicable) will be void under the following circumstances:

- The device has been damaged due to human factors, such as dropping, impact, water exposure, or unauthorized disassembly/modification.
- The device has malfunctioned due to improper use, mishandling, or usage beyond its intended design.
- The device has been disassembled, repaired, or modified by unauthorized personnel.
- Any other conditions that do not comply with our warranty policy.

12 Contact Information

Refer to <https://brtchip.com/contact-us/> for contact information.

Distributor and Sales Representatives

Please visit the Distribution Network – IC & Module (brtchip.com) page for the contact details of our distributor(s) and sales representative(s) in your country.

System and equipment manufacturers and designers are responsible to ensure that their systems, and any Bridgetek Pte Ltd (BRTChip) devices incorporated in their systems, meet all applicable safety, regulatory and system-level performance requirements. All application-related information in this document (including application descriptions, suggested Bridgetek devices and other materials) is provided for reference only. While Bridgetek has taken care to assure it is accurate, this information is subject to customer confirmation, and Bridgetek disclaims all liability for system designs and for any applications assistance provided by Bridgetek. Use of Bridgetek devices in life support and/or safety applications is entirely at the user's risk, and the user agrees to defend, indemnify and hold harmless Bridgetek from any and all damages, claims, suits, or expense resulting from such use. This document is subject to change without notice. No freedom to use patents or other intellectual property rights is implied by the publication of this document. Neither the whole nor any part of the information contained in, or the product described in this document, may be adapted, or reproduced in any material or electronic form without the prior written consent of the copyright holder. Bridgetek Pte Ltd, 1 Tai Seng Avenue, Tower A, #03-05, Singapore 536464. Singapore Registered Company Number: 201542387H.

Appendix A – References

Document References

[BT817 Datasheet](#)

[RP2040 Datasheet](#)

[EFM8BB1 Datasheet](#)

Acronyms and Abbreviations

Terms	Description
BLE	Bluetooth Low Energy
CTP	Capacitive Touch Panel
DC	Direct Current
EVE	Embedded Video Engine
FPC	Flexible Printed Circuit
GPIO	General Purpose Input Output
HMIs	Human Machine Interfaces
IC	Integrated Circuit
I2C	Inter-Integrated Circuit
LCD	Liquid Crystal Display
LED	Light Emitting Diode
LEDA	Light Emitting Diode Anode
LEDK	Light Emitting Diode Cathode
LVDS	Low Voltage Differential Signaling
MCU	Micro Controller Unit
PC	Personal Computer
PCB	Printed Circuit Board
PCAP	Projected Capacitive
PCBA	Printed Circuit Board Assembled
PoE	Power-over-Ethernet

RS485	Recommended Standard #485
PWM	Pulse Width Modulation
QSPI	Quad Serial Peripheral Interface
SD Card	Secure Digital Card
SPI	Serial Peripheral Interface
TFT	Thin Film Transistor
ToF	Time of Flight
UART	Universal Asynchronous Receiver/ Transmitter
USB	Universal Serial Bus
XIP	Execute In Place

Appendix B – List of Tables & Figures

List of Tables

Table 1 - Part Number/Ordering Information.....	2
Table 2 - CN3 Pinout.....	11
Table 3 - CN7 Pinout.....	11
Table 4 - CN9 Pinout.....	12
Table 5 - CN12 Pinout.....	12
Table 6 - CN14 Pinout.....	12
Table 7 - CN17 Pinout.....	13
Table 8 - CN22 Pinout.....	14
Table 9 - CN23 Pinout.....	14
Table 10 - CN5 Pinout.....	14
Table 11 - CN13 Pinout.....	15
Table 12 - CN18 Pinout.....	15
Table 13 - CN24 Pinout.....	15
Table 14 - JST8 Port Pin Function.....	23
Table 15 - JST4 Port Pin Function.....	24
Table 16 - JST8-RJ45 Cable Pin Definition.....	25
Table 17 - Operating Voltage and Current.....	26
Table 18 - Optical Specifications.....	27
Table 19 - Package Contents.....	30

List of Figures

Figure 1 - Front View of IDP-1000-04A Module.....	5
Figure 2 - Back View of IDP-1000-04A Module.....	5
Figure 3 - Mainboard PCBA Front View.....	6
Figure 4 - Mainboard PCBA Back View.....	6
Figure 5 - Sensor Board PCBA Front View.....	6
Figure 6 - Sensor Board PCBA Back View.....	7
Figure 7 - Sound Board PCBA Front View.....	7
Figure 8 - Sound Board PCBA Back View.....	7
Figure 9 - LED board PCBA- Front View.....	7
Figure 10 - LED board PCBA- Back View.....	7
Figure 11 - Main PCB Top Layer.....	8
Figure 12 - Main PCB Bottom Layer.....	9
Figure 13 - Sensor PCB Top Layer.....	9
Figure 14 - Sensor PCB Bottom Layer.....	9
Figure 15 - Sound PCB Top Layer.....	9

Figure 16 - Sound PCB Bottom Layer	9
Figure 17 - LED PCB Top Layer.....	10
Figure 18 - LED PCB Bottom Layer.....	10
Figure 19 - Main board Power circuit & Sound board	17
Figure 20 - BT817 EVE Graphic Controller.....	18
Figure 21 - RP2040 Microcontroller	19
Figure 22 - RGB to LVDS Conversion.....	20
Figure 23 - Sensors and LED Strip	21
Figure 24 - IDP-1000-04A Display Front View.....	22
Figure 25 - IDP-1000-04A Display Rear View.....	22
Figure 26 - JST8 Port Pin Orientation	23
Figure 27 - JST4 Port Pin Orientation	24
Figure 28 - JST8-RJ45 Cable Pin Orientation	25
Figure 29 - IDP-1000-04A Connection to Host with Use of PoE Splitter.....	25
Figure 30 - DC Driver Test Circuits	26
Figure 31 - IDP-1000-04A Display Dimensions	28
Figure 32 - Panel Mount Bracket Drill Holes Drawings (Front View)	29
Figure 33 - Wall Mount.....	30
Figure 34 - Electrical Junction Box Mount	31
Figure 35 - Glass Mount	31
Figure 36 - VESA Mount (100X100)	32
Figure 37 - RJ45-JST8 Cable Wiring Direction Options.....	32
Figure 38 - Remove screws to detach back cover	33
Figure 39 - Main PCBA and Speaker Board.....	33
Figure 40 - Debugging and Commonly Use Connectors.....	34
Figure 41 - Touch Calibration	35
Figure 42 - Bridgetek Logo	35
Figure 43 - Downloading Developer's Firmware	36

Appendix C – Revision History

Document Title: IDP-1000-04A Touch Display Module Datasheet
Document Reference No.: BRT_000449
Clearance No.: BRT#221
Product Page: <https://brtchip.com/product/idp-1000-04a>
Document Feedback: [Send Feedback](#)

Revision	Changes	Date
Version 1.0	Initial Release	26-01-2025
Version 1.1	Updated the following – Product Name; Part Number/Ordering Information; Product page hyperlink; Github hyperlink Added Warranty Statement section	07-04-2025